

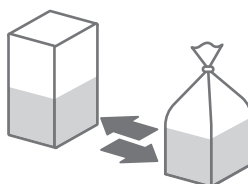

**358PL**  
**408PL**  
**508PL**  
**608PL**  
**355/357AL**  
**405/407AL**







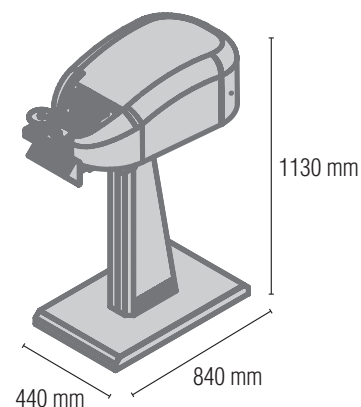

Applicano la chiusura salva-freschezza in plastica "clipband" o il sigillo di garanzia in alluminio a confezioni alimentari già riempite. Il sacchetto viene inserito manualmente dall'operatore all'interno del passaggio macchina. Start ciclo con micro pneumatico.

They apply a plastic "clipband" as fresh-saver or aluminium band as "warranty-seal" to already filled food bags. Manual infeed by operator into machine passage. Start cycle by micro pneumatic.



## Dati e modelli Models and Technical Data



	358PL	408PL	508PL	608PL	355/357AL	405/407AL
Tipologia sigillo Closure Type	 Clipband plastica Plastic Clipband	 Clipband plastica Plastic Clipband	 Clipband plastica Plastic Clipband	 Clipband plastica Plastic Clipband	 Sigillo alluminio Aluminium Band	 Sigillo alluminio Aluminium Band
Lunghezza sigillo mm Closure Length mm	35	40	50	60	35	40
Alimentazione Operation	Pneumatica Pneumatic	Pneumatica Pneumatic	Pneumatica Pneumatic	Pneumatica Pneumatic	Pneumatica Pneumatic	Pneumatica Pneumatic
Pressione aria Air Pressure	7 BAR	7 BAR	7 BAR	7 BAR	7 BAR	7 BAR
Consumo aria Air Consumption	2,1 Lt/ciclo 2,1 Lt/Cycle	2,1 Lt/ciclo 2,1 Lt/Cycle	2,1 Lt/ciclo 2,1 Lt/Cycle	2,1 Lt/ciclo 2,1 Lt/Cycle	2,1 Lt/ciclo 2,1 Lt/Cycle	2,1 Lt/ciclo 2,1 Lt/Cycle
Max diametro chiusura mm Max. Closure Diameter mm	10	15	20	25	10	15
Capacità meccanica/minuto Mechanical Capacity/Min	40	40	40	40	40	40
Capacità produttiva/minuto Production Capacity/Min	30	30	30	30	30	30
Peso netto/lordo Kg Net/Gross Weight Kg	33/45	33/45	33/45	33/45	33/45	33/45
Dimensioni imballo mm Packing Dimensions mm	950x680x650	950x680x650	950x680x650	950x680x650	950x680x650	950x680x650
Datario Date Printer	Optional	Optional	Optional	Optional	Di serie Standard	Di serie Standard

Aggiornamento scheda: marzo 2018. Updating sheet: March 2018.

### Optionals

Datario incisione, Datario inchiostro, Datario HP, Pedale  
Embossing Printer, Ink Printer, HP Printer, Footswitch

L'uso ridotto di energie contribuisce al rispetto dell'ambiente.  
Low energy consumption contributes to environmental respect.



Mediapac Srl SS 11 Fracanzana, 23 36054 Montebello (VI)  
T +39 0444 649151 F +39 0444 649495 info@mediapac.it